

Raigoza Group Research

Surface Functionalization/Patterning

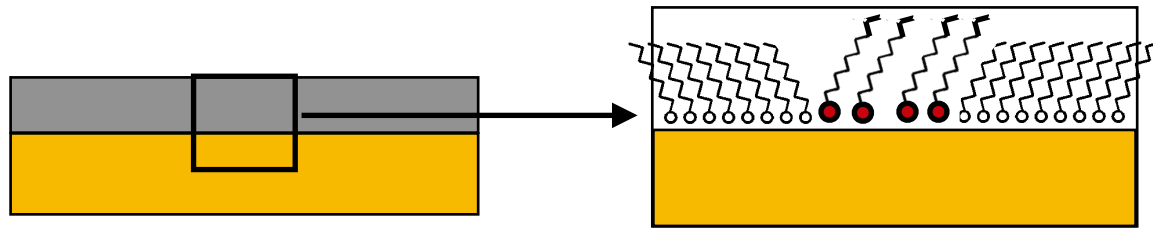

Mechanochemistry

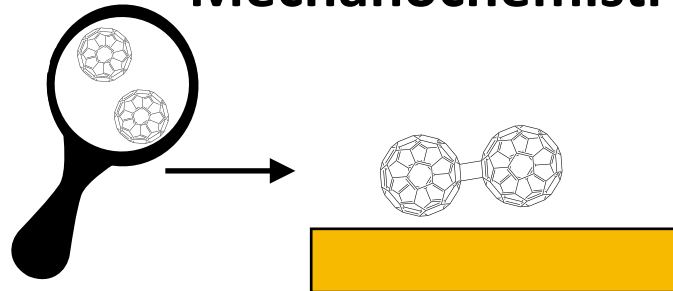

Sensors

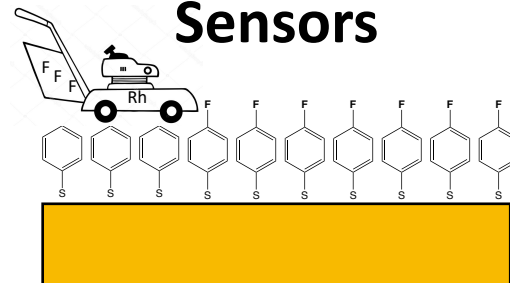

Particle Functionalization

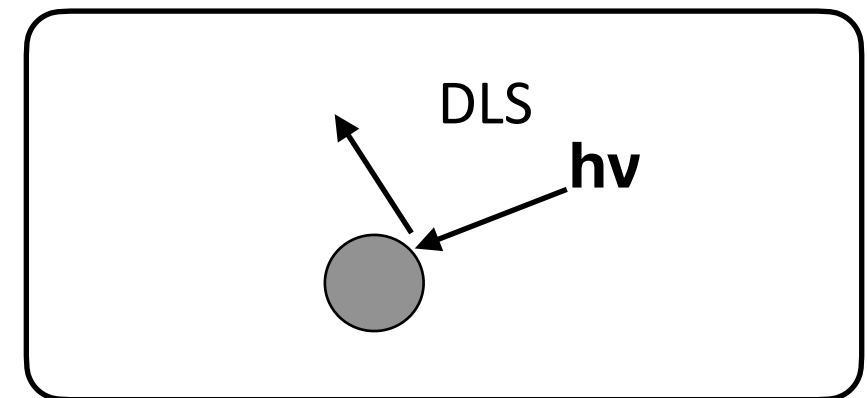
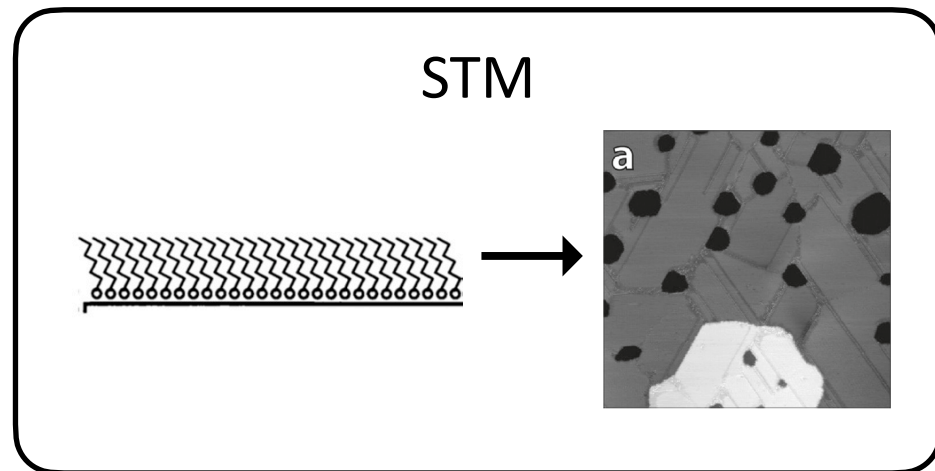
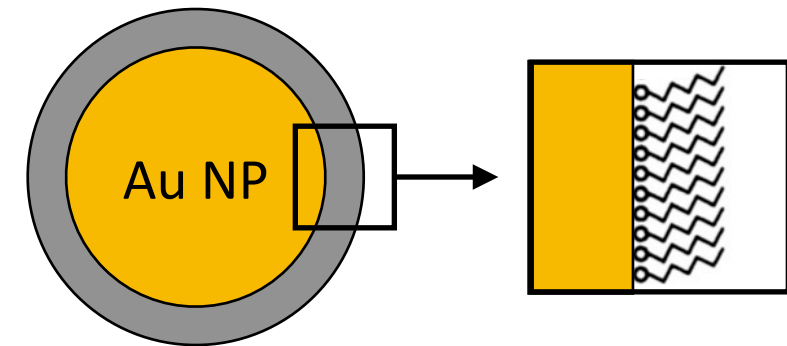

Biodesorption On Surfaces

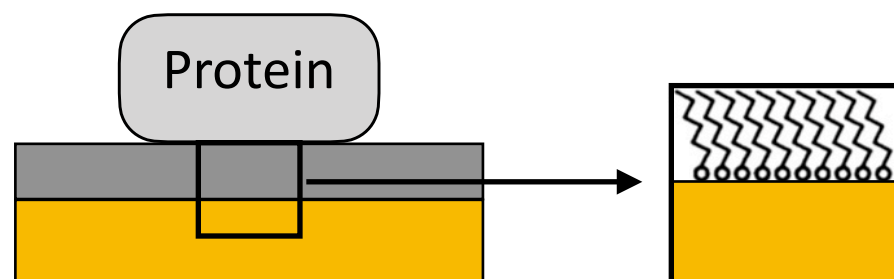

Particle Bio-Functionalization

